

## Product Overview

### NCV7708B: Motor Driver, Double Hex

For complete documentation, see the data sheet.

The NCV7708B is a fully protected Hex Half Bridge Driver designed specifically for automotive and industrial motion control applications. The six low and high side drivers are freely configurable and can be controlled separately. This allows for high side, low side, and H Bridge control. H Bridge control provides forward, reverse, brake, and high impedance states. The drivers are controlled via a standard SPI interface.

#### Features

- Ultra Low Quiescent Current Sleep Mode
- Six Independent High Side and Six independent Low Side Drivers
- Internal Upper and Lower Clamp Diodes
- Integrated Freewheeling Protection (LS and HS)
- Configurable as H Bridge Drivers
- 0.5 A Continuous (1 A peak) Current
- $R_{DS(on)} = 0.8 \text{ Ohm (typ)}$
- 5 MHz SPI Control
- Compliant with 5 V and 3.3 V Systems
- Overvoltage Lockout

For more features, see the data sheet

#### Benefits

- Low battery current drain
- Flexible applications
- Reduced external components
- Reduced external components
- Can drive bidirectional loads
- Drive current capability
- Low power dissipation
- High speed control is possible
- Will function with a variety of controller voltages
- Self protects for overvoltage conditions

#### Applications

- DC Motor Management
- Automotive HVAC

#### End Products

- Automobiles
- Industrial Equipment

#### Application Diagram

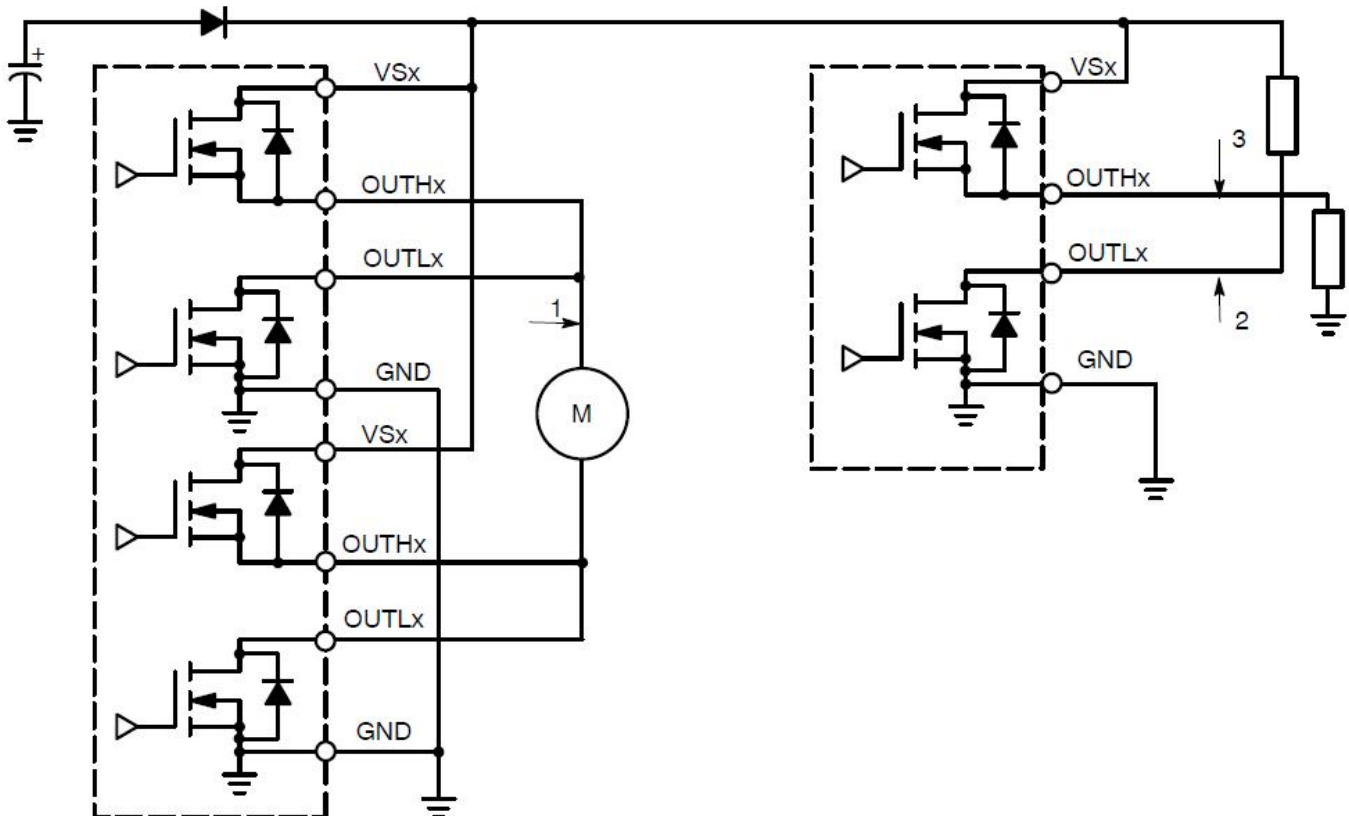

For more information please contact your local sales support at [www.onsemi.com](http://www.onsemi.com).

Created on: 6/1/2020